

Cylindrical Sensor Offers Adjustable Detecting Distance

- Permits non-contact detection of metallic and non-metallic objects such as glass, wood, water, oil and plastic
- Allows indirect detection of materials inside non-metallic containers
- Adjustable detecting distance from 3 to 25 mm
- Built-in amplifier accepts wide range of supply voltages and switches up to 200 mA
- Mounting bracket included

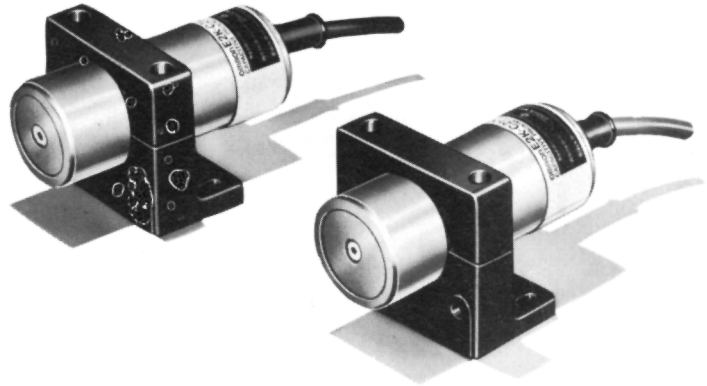

Ordering Information

■ SENSORS

Type		Unshielded		
Nominal detecting distance		3 to 25 mm (0.12 to 0.98 in), adjustable		
Output type		NO	NC	
Part number	AC switching type (SCR)		E2K-C25MY1	E2K-C25MY2
	DC switching type	NPN	E2K-C25ME1	E2K-C25ME2
		PNP	E2K-C25MF1	E2K-C25MF2

■ REPLACEMENT PARTS

Description	Part number
Mounting bracket for E2K-C (supplied with sensor)	Y92E-A34

Specifications

Part number		E2K-C25M□□	E2K-C25MY□
Sensor type		Capacitive	
Body	Size	34 mm (1.34 in) diameter	
	Type	Unshielded	
Supply voltage		10 to 40 VDC, 10% max. permissible ripple peak to peak	90 to 250 VAC, 50/60 Hz
Current consumption		10 mA max. at 12 VDC 15 mA max. at 24 VDC	1 mA max. at 100 VAC 2 mA max. at 200 VAC
Detectable object type		Metallic and non-metallic objects	
Sensitivity		Adjustable	
Effective maximum detecting distance (with standard target)		3 to 25 mm (0.12 to 0.98 in)	
Standard target size (grounded mild steel, L x W x H)		50 x 50 x 1 mm (2.0 x 2.0 x 0.04 in)	
Differential travel		15% max. of detecting distance	
Control output	AC solid-state	Type	— SCR-NO (E2K-C25MY1) SCR-NC (E2K-C25MY2)
		Max. load	200 mA
		Min. load	5 mA
		Max. off-state leakage current	See "Leakage Current Characteristics" graph in Engineering Data
	DC solid-state	Max. on-state voltage drop	— 2V max.
		Type	NPN-NO open collector with pull-up NPN-NC open collector with pull-up PNP-NO open collector with pull-down PNP-NC open collector with pull-down
		Max. load	200 mA
		Max. on-state voltage drop	See "Residual Load Voltage" graph in Engineering Data
Response frequency		70 Hz	10Hz
Circuit protection	Output short-circuit	Not provided	
	DC power supply reverse polarity	Provided	Not provided
	Weld field immunity	Not provided	
	RFI immunity	Not provided	
Indicators		Target Present (red LED)	Output Operation (red LED)
Materials	Housing	ABS/PC	
	Sensing face	ABS	
	Cable sheath	PVC	
Mounting		Bracket Y92E-A34 included	
Connections	Prewired	Three-conductor cable, 2 m (6.56 ft) length	Two-conductor cable, 2 m (6.56 ft) length
Weight with cable		Approx. 200 g (7.0 oz.)	
Enclosure ratings	UL	1	
	NEMA	1, 4, 12, 13	
	IEC 144	IP67	
Approvals	UL	—	Listed, File Number E76675
	CSA	—	Certified, File Number LR45951
Ambient operating temperature		-25° to 70°C (-13° to 158°F)	
Vibration		10 to 55 Hz, 1.5 mm (0.06 in) double amplitude	
Shock		Approx. 50 G's	

Operation

OUTPUT CIRCUIT DIAGRAMS AND TIMING CHARTS

DC Switching Types

E2K-C25ME□

The dotted line shows a transistor circuit load.

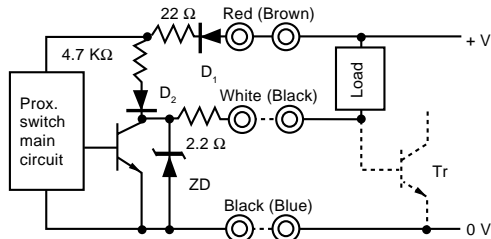

Note: IEC colors are shown in parentheses.

E2K-C25MF□

The dotted line shows a transistor circuit load.

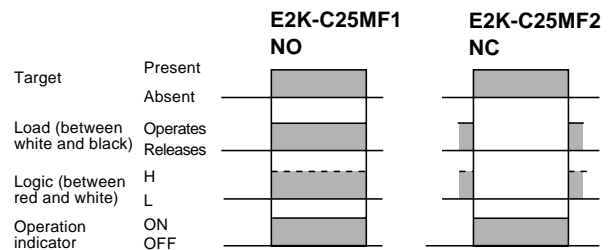
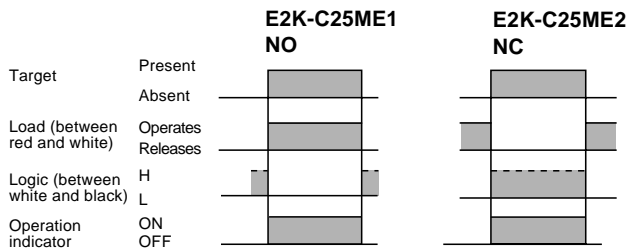
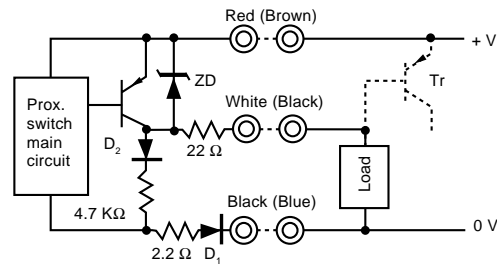

AC Switching Types

E2K-C25MY□

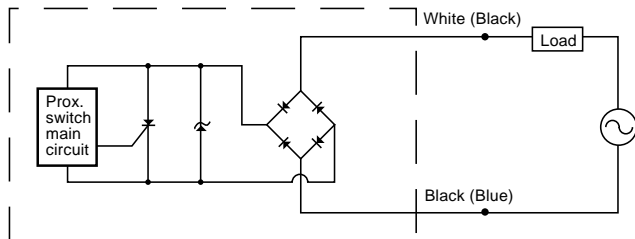

Note: IEC colors are shown in parentheses.

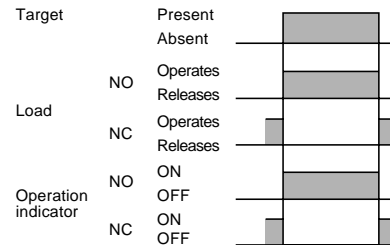

Engineering Data

Operating Range

E2K-C25MY1

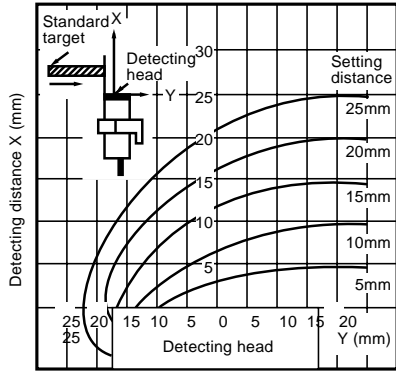

Detecting Distance vs. Size and Material of Target

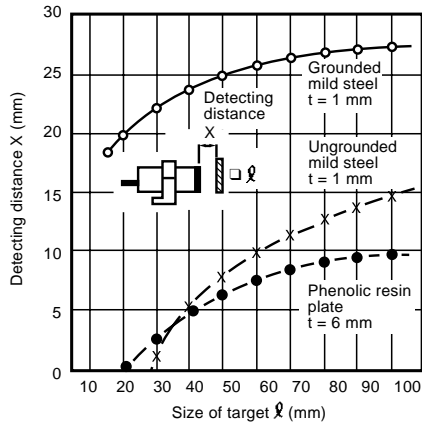

Detecting Distances of Common Materials

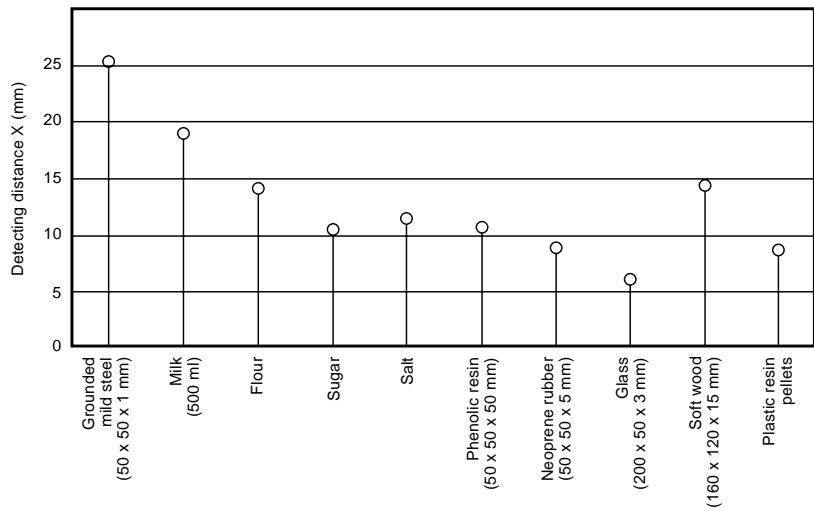

Residual Load Voltage Characteristics

DC switching types
E2K-C25M□□

24VDC

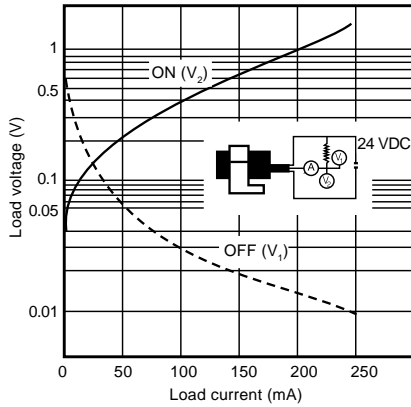

$$R \leq \frac{V_s}{10 - i} \text{ (k}\Omega\text{)} \quad P > \frac{V_s^2}{R} \text{ (mW)}$$

P : Power rating of bleeder resistor
i : Load current (mA)
V_s : Supply voltage (V)

AC switching types
E2K-C25MY□

100 VAC

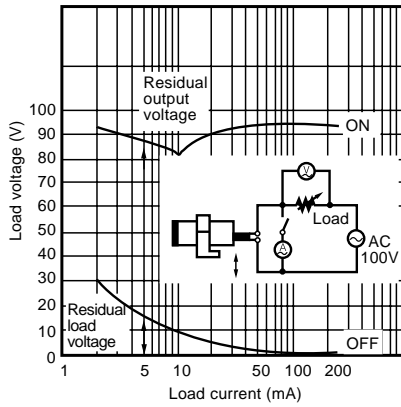

200 VAC

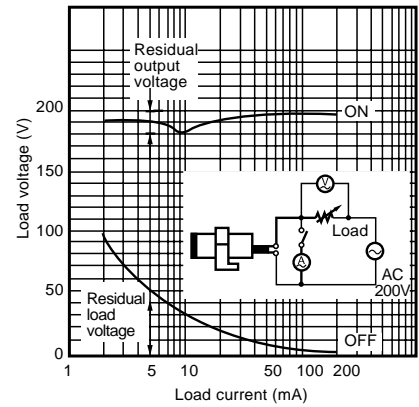

Note: When the current rating of the load is less than 10 mA, false operation may occur. This is normal, and the problem can be cured by installing a bleeder resistor in parallel with the load. Use the formulas given here to calculate the power rating and value of the resistor.

Leakage Current Characteristics

AC switching types
E2K-C25MY□

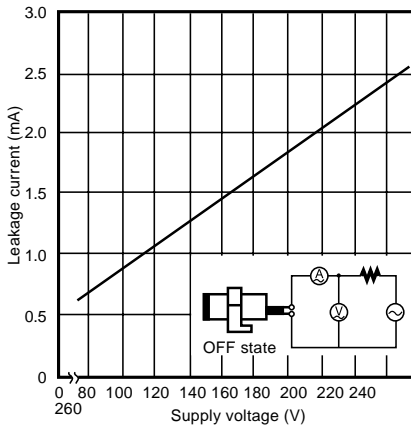

Dimensions

Unit: mm (inch)

■ SENSORS

E2K-C25M□□

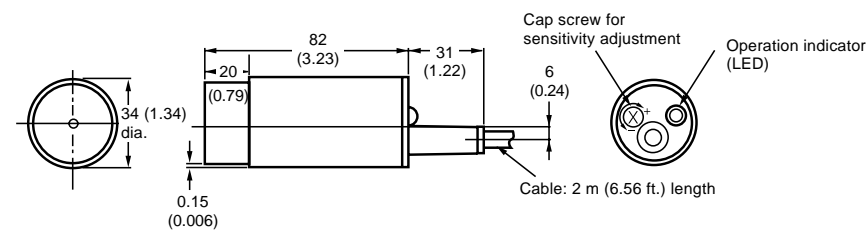

Note: Cable may be extended to 200 m (656 ft).

Unit: mm (inch)

■ MOUNTING BRACKET

Y92E-A34 (supplied with sensor)

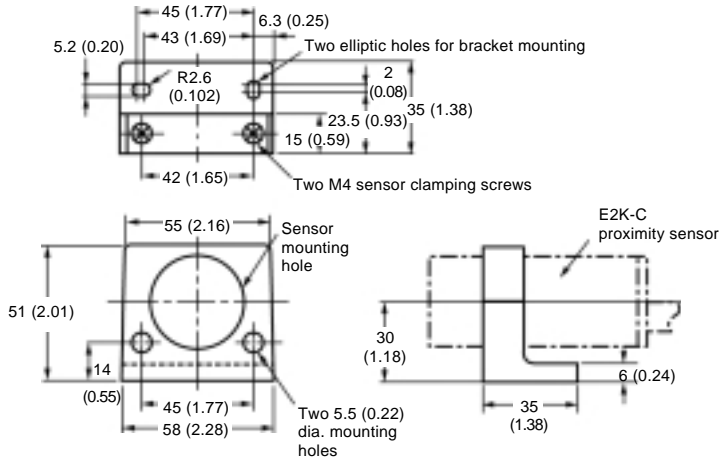

Precautions

■ EFFECTS OF SURROUNDING METALS

When mounting the sensor, be sure to provide the minimum distance shown in the diagram. This prevents the sensor from being affected by metallic objects other than the target. Also, when using the supplied mounting bracket, be sure to allow a distance of 20 mm or more between the detecting face and the mounting bracket.

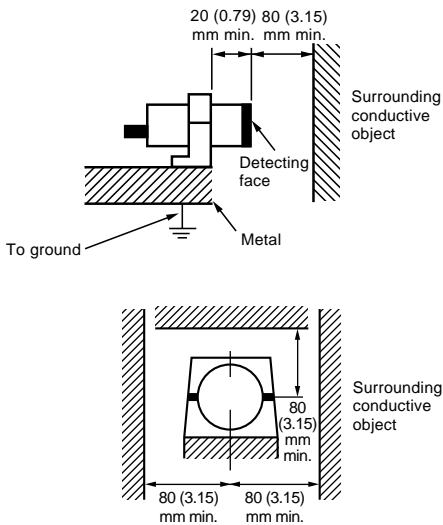

■ MUTUAL INTERFERENCE

To prevent mutual interference, be sure to space the two sensors at a distance greater than that shown in the diagrams.

Opposed mounting

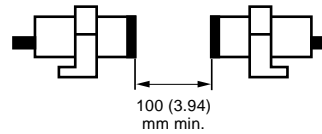

Parallel mounting

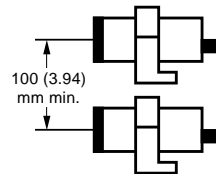

■ SENSITIVITY ADJUSTMENT

NO type (E2K-C25M□1)

Remove protective rubber plug to gain access to sensitivity adjustment screw. Use the screwdriver provided with each sensor to turn the sensitivity adjustment screw.

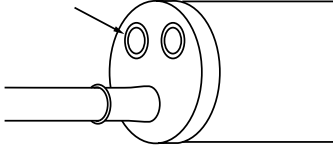

- 1) Remove any targets from in front of the sensor. Turn the sensitivity adjustment screw **CLOCKWISE** until the sensor turns ON and the indicator illuminates.

Sensitivity adjustment



Stop when the sensor turns ON

- 2) Place a target in front of the sensor. Turn the sensitivity adjustment screw **COUNTERCLOCKWISE** until the sensor turns OFF and the indicator goes out. Note the number of revolutions between OFF and ON positions.

Sensitivity adjustment



Stop when the sensor turns OFF

- 3) If the number of revolutions is greater than one and a half, the sensor will provide stable output. If the number of revolutions is less than one and a half, increase or decrease the distance between the target and the sensing face as necessary to allow at least one and a half revolutions between the ON and OFF positions.

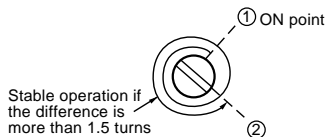

- 4) Now turn the sensitivity adjustment screw **CLOCKWISE** to the midpoint between the ON and OFF points.

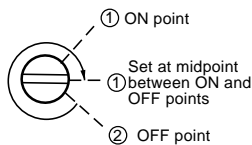

- 5) If the distance between the target and the sensor is not constant, perform the first adjustment operation (#1) when the target is at the closest position to the sensor. Then perform the second adjustment operation (#2) when the target is at the farthest position from the sensor.

NC type (E2K-C25M□2)

The sensitivity adjustment procedure for NC type proximity sensors is the same as for NO type sensors, with the exception that ON and OFF operations of the proximity sensor and ON and OFF points in the adjustment procedure are exactly reversed.

■ USING METAL CONDUIT

If a high voltage of power line runs near the proximity sensor cable, be sure to wire the sensor cable through a metal conduit to protect the sensor from malfunctioning or damage.

■ SURGE PROTECTION

The proximity sensor is provided with a surge suppressor circuit. However, if any large surge generating source (i.e., motor, welding machine, etc.) exists in the vicinity of the proximity sensor, insert a surge suppressor (such as a varistor) into the surge generating source.

NOTE: DIMENSIONS ARE SHOWN IN MILLIMETERS. To convert millimeters to inches divide by 25.4.

OMRON

OMRON ELECTRONICS, INC.

One East Commerce Drive
Schaumburg, IL 60173

1-800-55-OMRON

OMRON CANADA, INC.

885 Milner Avenue
Scarborough, Ontario M1B 5V8

416-286-6465