

Ultrasonic Displacement Sensor E4PA-N

Now, more advanced with a new mutual interference prevention function.

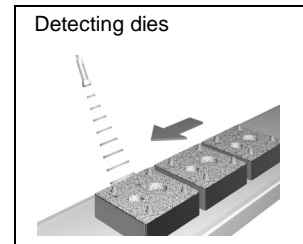

Application Examples

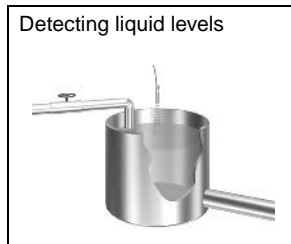

Features

- High-precision detection with a wide range of measurements.

Four types of Sensors are available with maximum sensing distances of 0.5 m, 2 m, 4 m, and 6 m. With the 0.5-m type, a repeat accuracy of 1 mm or better has been achieved.

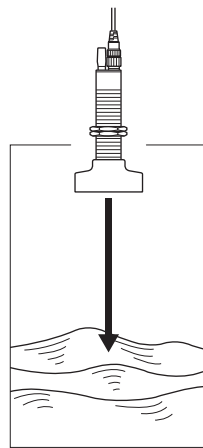

- A setting plug with a temperature compensation function makes it easy to set the sensing range.

The sensing range can be set by the Setting Plug, which is included with the Sensor. No special controller is required. The Setting Plug's built-in temperature sensor provides superior temperature characteristics of $\pm 1\%$ FS.



- The Sensor is ultrasonic, so it is not affected by the color of objects.

A variety of materials can be measured, including transparent and reflective objects. Measurements are performed with no contact, so even highly-viscous liquids are no problem.

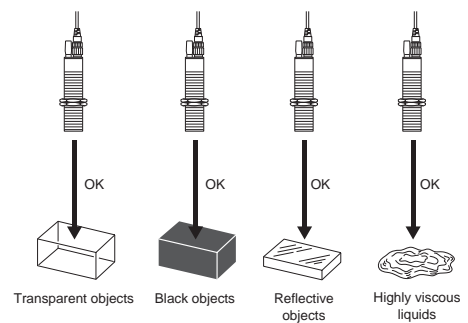

- The mutual interference prevention function allows up to five Sensors to be used in close proximity.

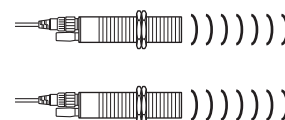



Ordering Information

■ Sensors

Sensing range	Model
50 to 500 mm	E4PA-LS50-M1-N
120 to 2,000 mm	E4PA-LS200-M1-N
240 to 4,000 mm	E4PA-LS400-M1-N
400 to 6,000 mm	E4PA-LS600-M1-N

■ Accessories (Order Separately)

Sensor I/O Connectors

Cable	Shape	Cable length		Model
Standard Cable	Straight 	2 m	5 conductors	XS2F-D521-DG0-A
		5 m		XS2F-D521-GG0-A
4-to-5 Conductor Conversion Cable		0.3 m	---	E4PA-C01

Setting Plug

Shape	Model
	E4PA-P01

Specifications

■ Ratings/Characteristics

Item	E4PA-LS50-M1-N	E4PA-LS200-M1-N	E4PA-LS400-M1-N	E4PA-LS600-M1-N
Sensing range	50 to 500 mm	120 to 2,000 mm	240 to 4,000 mm	400 to 6,000 mm
Dead band distance	0 to 50 mm	0 to 120 mm	0 to 240 mm	0 to 400 mm
Standard sensing object	100 × 100 mm flat plate			
Applied frequency	Approx. 380 kHz	Approx. 180 kHz	Approx. 85 kHz	Approx. 65 kHz
Response time	63 ms max.	195 ms max.	440 ms max.	850 ms max.
Power supply voltage	10 to 30 VDC; ripple (p-p): 10% max.			
Power consumption	1,800 mW max.			
Analog output	Current output: 4 to 20 mA (Allowable load resistance: 500 Ω max.) Voltage output: 0 to 10 V (1,000 Ω min.)			
Mutual interference cycle time	10 ms	34 ms	77 ms	143 ms
Linearity	±1% FS max.			
Repeat accuracy (See note.)	0.1% FS max.			
Temperature influence	±1% FS of output value at +23°C in the temperature range of -10 to 55°C			
Voltage influence	±5% FS max. within rated power supply voltage range			
Ambient temperature	Operating: -10 to 55°C (with no icing or condensation) Storage: -40 to 85°C (with no icing or condensation)			
Ambient humidity	Operating and storage: 35% to 85% (with no condensation)			
Insulation resistance	50 MΩ min. (at 500 VDC) between current-carrying parts and case			
Dielectric strength	1,000 VAC (50/60 Hz) for 1 min between current-carrying parts and case			
Vibration resistance	Destruction: 10 to 55 Hz, 1-mm double amplitude for 2 hours each in X, Y, and Z directions			
Shock resistance	Destruction: 300 m/s ² three times each in X, Y, and Z directions			
Connection method	5-conductor connector			
Degree of protection	IEC60529: IP65			
Weight (packed)	Approx. 240 g		Approx. 320 g	Approx. 400 g
Materials	Case: Stainless steel (SUS303) Sensing surface: PBT resin, polyurethane, glass epoxy resin			
Accessories	Operation Manual			

Note: Values are given one hour after power-up. The outputs may fluctuate due to external disturbances.

Engineering Data

Sensing Distances (Typical Examples)

E4PA-LS50-M1-N

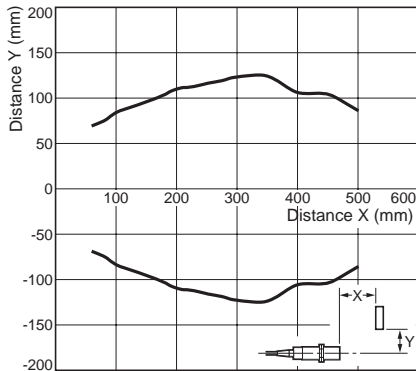

E4PA-LS200-M1-N

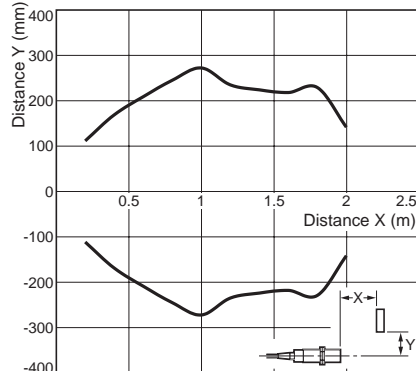

E4PA-LS400-M1-N

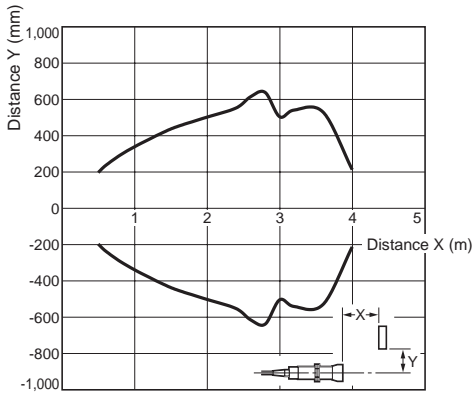

E4PA-LS600-M1-N

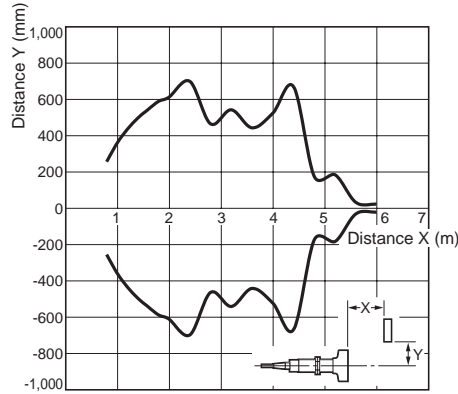

Output Circuit

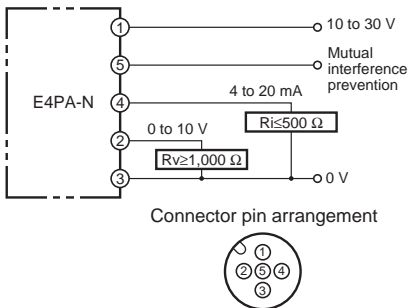

Sensor I/O Connector

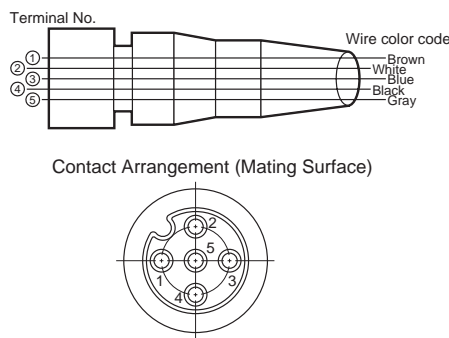

Class	Wire color code	Pin No.	Application
For DC	Brown	1	Power supply (+V)
	White	2	Voltage output
	Blue	3	Power supply (0 V)
	Black	4	Current output
	Gray	5	Mutual interference prevention input

Nomenclature

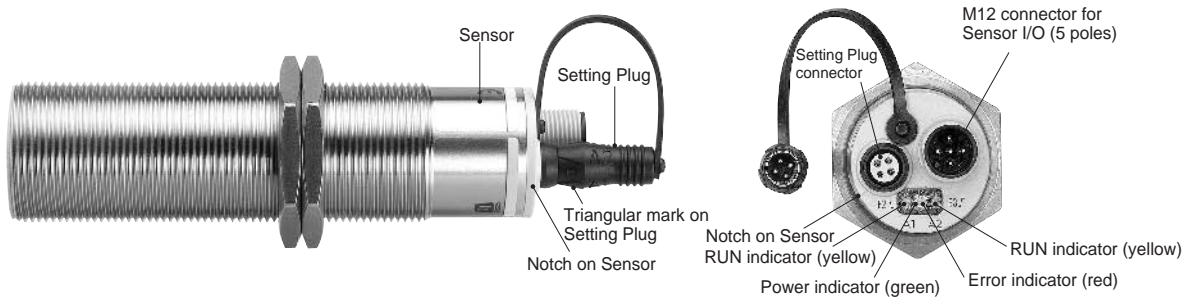

Setting Plug

The E4PA-N is set up by aligning the notch on the Sensor with one of the triangular marks on the Setting Plug and inserting the Setting Plug into the Sensor.

Position	Function
A1	Nearest sensing point A1
A2	Farthest sensing point A2
E2/E3 (See note 1.)	Analog output characteristics <ul style="list-style-type: none"> 1. Increase: As the distance increases, the output increases. (LED A1 flash.) 2. Decrease: As the distance increases, the output decreases. (LED A2 flash.) 3. Output from 0 mm: Increases from the sensing surface to point A2. (LED A1 and A2 flash.) (See note 2.)
T	Temperature compensation setting (normal operating condition)

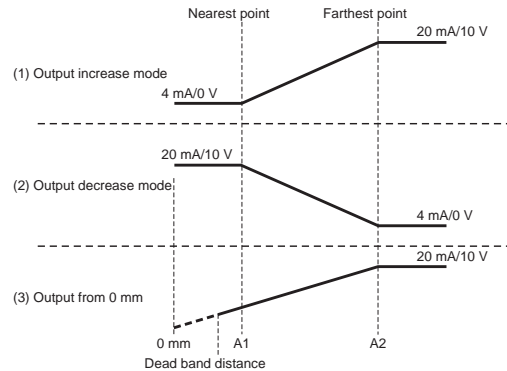

- Note:**
- Analog Output Characteristics when Setting Plug is inserted at E2/E3 Position:
The analog output characteristics will change from (1) to (2) to (3), in that order, each time the Setting Plug is inserted with the E2/E3 position aligned with the notch on the Sensor.
 - The analog output value can be compensated so that the sensing surface (0 mm) of the Sensor is 4 mA/0 V regardless of the nearest sensing point setting.
This function is useful when using Controllers without a scaling function. Sensing is not possible, however, for characteristics within the dead band distance and current/voltage output values may not be stable.

Indicator Display and Analog Output Characteristics

Status		Setting Plug position	Power indicator (green)	Error indicator (red)	RUN indicator A1 (yellow)	RUN indicator A2 (yellow)	Analog output
Normal operation	Temperature compensation	T	Lit	Not lit	Lit/Not lit (See note 1.)	Lit/Not lit (See note 1.)	Present value
	Setting Plug not inserted		Not lit	Lit	Lit/Not lit (See note 1.)	Lit/Not lit (See note 1.)	Present value
	Malfunction sensing (when detecting external disturbance)		Not lit	Flashing	Lit/Not lit (See note 2.)	Lit/Not lit (See note 2.)	No change or unstable
Sensing distance A1 setting	With sensing object	A1	Flashing	Not lit	Flashing	Not lit	No change
	Without sensing object		Not lit	Flashing	Flashing	Not lit	No change
Sensing distance A2 setting	With sensing object	A2	Flashing	Not lit	Not lit	Flashing	No change
	Without sensing object		Not lit	Flashing	Not lit	Flashing	No change
Analog output characteristics setting	(1) Output increase mode	E2/E3	Lit	Not lit	Flashing	Not lit	No change
	(2) Output decrease mode		Lit	Not lit	Not lit	Flashing	No change
	(3) Output from 0 mm		Lit	Not lit	Flashing (synchronous)	Flashing (synchronous)	No change
Power turned ON		None	Flashing	Not lit	Previous status	Previous status	No change

- Note:**
- Lit: The sensing object is within the sensing range.
Not lit: The sensing object is not within the sensing range.

- Output indicator just prior to occurrence of malfunction.

Mutual Interference Prevention

The E4PA-N provides a sync input to prevent mutual interference. When the fifth pin of the Sensor I/O Connector's M12 Connector is interconnected, mutual interference can be prevented for up to five Units. The Sensors will mutually oscillate, however, causing a delay in measurement time by the mutual interference cycle time per Sensor × number of Units + response time. When the sync inputs are not connected, the mutual interference prevention function is disabled.

(For example, if three E4PA-LS200-M1-N are connected, the response time for one Sensor is $34 \text{ ms} \times 3 \text{ Sensors} + 195 \text{ ms} = 297 \text{ ms}$.)

Operation

Setup and Operating Procedure

The E4PA-N is factory-set for the decrease mode for analog output characteristics and for the maximum sensing range. These settings enable scaling with the connected device (e.g., the K3NX). In this case, only step 4 is required.

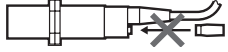

To change the analog output range, follow steps 1 to 4 below.

1. Preparation for Setup

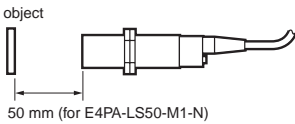
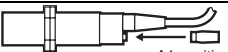
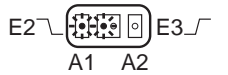
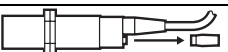
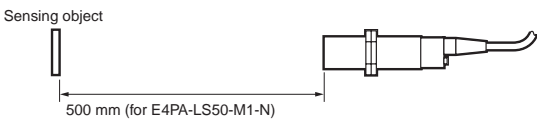
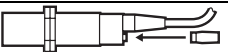
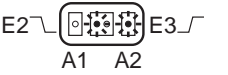

Step	Setting/Operation
1	Remove the Setting Plug. 
2	Turn ON the power. (See note.) 
3	Proceed to Step 2 <i>Setting Sensing Range</i> .

Note: Do not insert the Setting Plug yet. It must be inserted within five minutes after the power is turned ON, however, or the set-up will not be possible. If that happens, power up again and start over.

2. Setting Sensing Range

Step	Setting/Operation
1	Place the sensing object at the nearest point within the sensing range.  50 mm (for E4PA-LS50-M1-N)
2	Insert the Setting Plug at the A1 position. (Align the notch on the Sensor with the A1 triangular mark on the Setting Plug.) The power indicator (green) and the A1 RUN indicator (yellow) with flash, showing that the near distance has been correctly set.  A1 position 
3	Remove the Setting Plug. (In this state, the setting is confirmed and recorded.) 
4	Place the sensing object at the farthest point within the sensing range.  500 mm (for E4PA-LS50-M1-N)
5	Insert the Setting Plug at the A2 position. (Align the notch on the Sensor with the A2 triangular mark on the Setting Plug.) The power indicator (green) and the A2 RUN indicator (yellow) will flash, showing that the far distance has been correctly set.  A2 position 
6	Remove the Setting Plug. (In this state, the setting is confirmed and recorded.) 
7	Proceed to Step 3 <i>Setting Analog Output Characteristics Mode</i> .

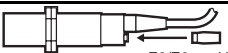
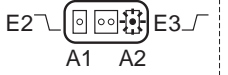
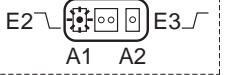
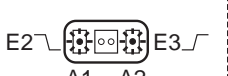
3. Setting Analog Output Characteristics Mode

Step	Setting/Operation
1	Insert the Setting Plug at the E2/E3 position. (Align the notch on the Sensor with the E2/E3 triangular mark on the Setting Plug.)  E2/E3 position A2 RUN indicator (yellow) flashing: ● Analog output characteristics: Decrease mode In this mode, the analog output decreases (20 to 4 mA/10 to 0 V) as the sensing object nears the E4PA within the sensing range.  E2 E3 A1 A2 The mode changes when the Setting Plug is reinserted at the E2/E3 position. A1 RUN indicator (yellow) flashing: ● Analog output characteristics: Increase mode In this mode, the analog output increases (4 to 20 mA/0 to 10 V) as the sensing object nears the E4PA within the sensing range.  E2 E3 A1 A2 The mode changes when the Setting Plug is reinserted at the E2/E3 position. A1 and A2 RUN indicators (yellow) flashing at the same time: ● Analog output characteristics: Output from 0 mm In this mode, the analog output decreases (20 to 4 mA/10 to 0 V) as the sensing object nears the E4PA between the farthest sensing point and 0 mm.  E2 E3 A1 A2 Note: Check the input impedance of connected devices and the analog output in <i>Ratings/Characteristics</i> (see page 2). 2 After the analog output characteristics have been set, remove the Setting Plug.  3 Proceed to Step 4 <i>Setting Temperature Compensation Mode</i> .

4. Setting Temperature Compensation Mode

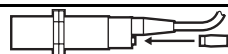
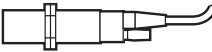
Step	Setting/Operation
1	Insert the Setting Plug at the T position. (Align the notch on the Sensor with the T triangular mark on the Setting Plug.)  T position
2	Leave the Setting Plug inserted where it is. (This completes the set-up.)  Note: To maintain the temperature compensation, leave the Setting Plug inserted during operation. If it is removed from the E4PA, the temperature compensation will be disabled.

Note: If the reflection from the Sensor is extremely weak, or if the sensing object is set outside of the sensing range, the error indicator (red) will flash to show that the sensing range is not accurately set. If the Setting Plug is left removed for five minutes or longer, temperature compensation will be disabled (status before setting).

If it becomes necessary to change the settings for step 2 (Sensing Range) or step 3 (Analog Output Characteristics Mode) after steps 1 through 4 have been completed, the contents of all the previous settings will be remembered, so only the items to be changed need to be reset. Go through the steps in order, from 1 to 4, and reset only the items to be changed.

Safety Precautions

■ Precautions for Safe Use

Design

Power Supply

If possible, use a power supply without overcurrent detection. This Sensor uses a DC-DC converter in the power supply circuit. If the power supply has overcurrent detection, the protective circuit may be activated by the inrush current.

Recommended power supply: OMRON S82-series Power Supply (Capacity: 15 W min.)

Wiring

Power Supply Voltage

Do not exceed the operating voltage range. Using a higher voltage or using an AC power supply (100 VAC or more) for a DC Sensor can cause explosion or burning.

Faulty Wiring

Be careful not to make wiring mistakes such as reversing the power supply polarity. Faulty wiring can cause explosion or burning.

Operating Environment

Do not use the Sensor in an environment where inflammable or explosive gas is present.

Others

- Do not attempt to disassemble, repair, or modify any Units. Any attempt to do so may result in malfunction, fire, or electric shock.
- Dispose of Sensors as industrial waste.

■ Precautions for Correct Use

Design

Sensor Ambient Temperature and Humidity

The acoustic velocity generally fluctuates approximately 0.17% with each 1°C of temperature change. For example, if the ambient temperature increases from 20 to 40°C, then the acoustic velocity will increase by 3.5%. Moreover, the acoustic velocity will increase by 2% in dry air compared with air with 100% humidity. Test the environmental conditions where the Sensor will actually be used.

Mutual Interference

Separate the Sensors as specified in the following table when using two or more Sensors in close proximity to one another. The mutual interference prevention function can be used with up to five Sensors.

Parallel Arrangement

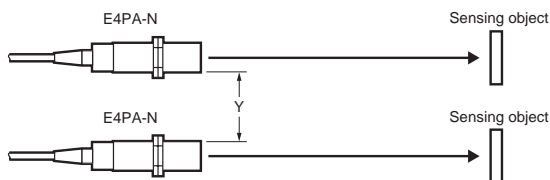

Note: The values shown in the following table are examples for reference only. The actual values will vary depending on the surface conditions of the sensing object, and on the ultrasonic waves that are reflected. Moreover, if the sensing object is inclined, the Y value in the table will be increased further.

Model	Y
E4PA-LS50-M1-N	0.3 m min.
E4PA-LS200-M1-N	1 m min.
E4PA-LS400-M1-N	2 m min.
E4PA-LS600-M1-N	2.5 m min.

Facing Arrangement



Model	Y
E4PA-LS50-M1-N	2 m min.
E4PA-LS200-M1-N	8 m min.
E4PA-LS400-M1-N	16 m min.
E4PA-LS600-M1-N	25 m min.

Sensing Object

- The sensing object may be solid, liquid, or powder, and the detection capability of the Sensor will vary depending on the surface conditions of the object. If the surface irregularities are no more than 0.2 mm, then the specified sensing distance will apply. Materials such as fine powder, felt, cotton, and other materials that absorb sound should be tested before using the Sensor.
- If the surface temperature of the sensing object is over 100°C, there will be very little ultrasonic reflection. Conduct tests before using the Sensor.

Influence of Sensing Angle

Ultrasonic Displacement Sensors can detect solid, liquid, or powder sensing objects, but the surface of the sensing object will affect the measurement. Dented surfaces or sensing objects with an angled surface require a tilt angle within 3° max. to achieve accurate sensing.



Installation

Mounting the Sensor

The Sensor must be mounted using the nuts provided, and tightened to a torque of 15 N·m max.

If the Sensor malfunctions due to noise, insert insulation between the Sensor and the mounting base (metal).

Atmosphere

- To ensure reliability and long service life, do not use the Sensor outdoors or in places that exceed the rated temperature.
- Ultrasonic sensors use air as the transmission medium, so if there are local temperature differences there may be malfunctioning due to reflection and refraction at the boundaries, and the detection distances change where wind blows. Therefore, the Sensor should not be used near equipment such as forced-air ventilators.
- Jets from air nozzles include various frequencies, so they can affect the Sensor and should not be used nearby.
- Water drops on the Sensor surface shorten the sensing distance.

Wiring Considerations

Cable Length

The cable must be no longer than 10 m.

High-voltage Lines

Do not lay power supply cable for the E4PA-N Ultrasonic Displacement Sensor together with high-voltage lines or power lines. Placing them in the same conduit or duct may result in interference, damage, or malfunction.

Dimensions

Note: All units are in millimeters unless otherwise indicated.

Sensors

E4PA-LS50-M1-N

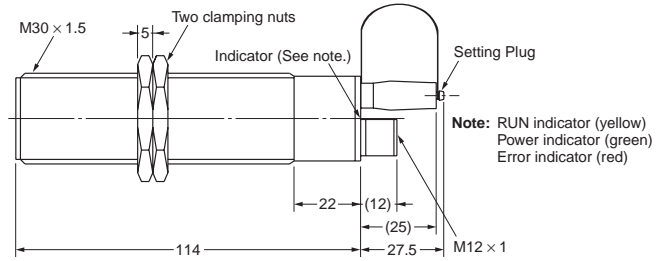
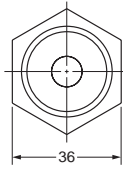

E4PA-LS200-M1-N

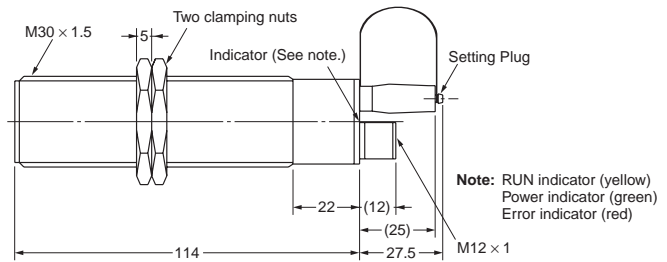
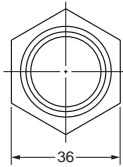

E4PA-LS400-M1-N

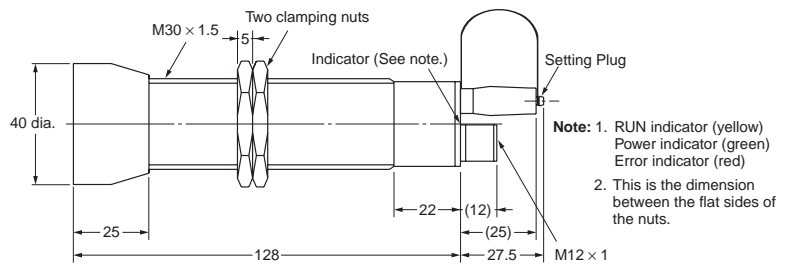
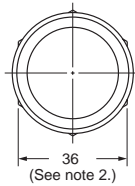

E4PA-LS600-M1-N

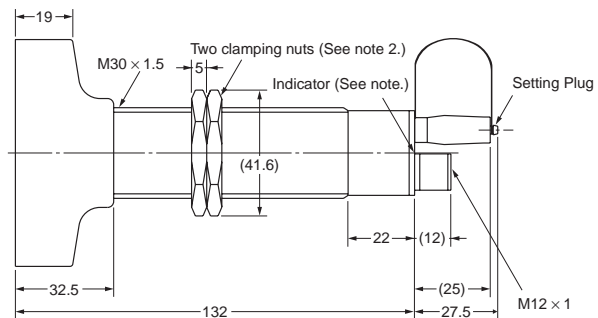
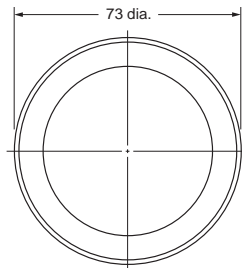

■ Accessories (Order Separately)

Standard (Straight)

XS2F-D521-DG0-A (L=2 m)
 XS2F-D521-GG0-A (L=5 m)

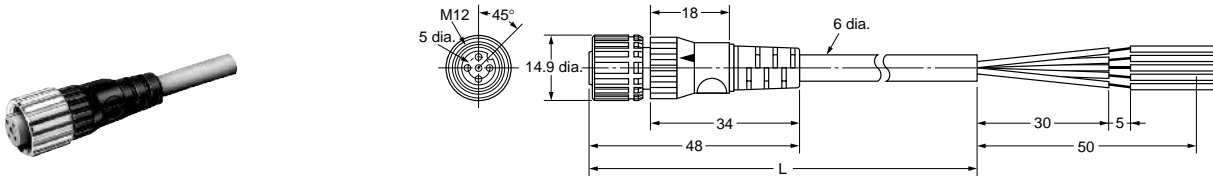

4-to-5 Conductor Conversion Cable

E4PA-C01

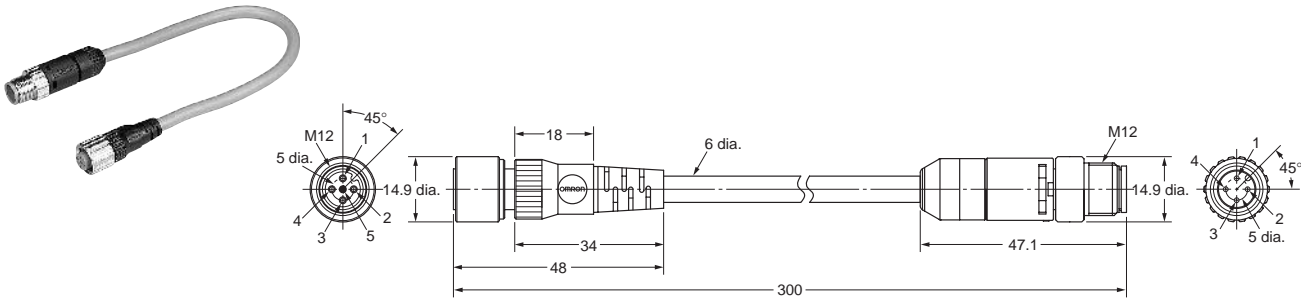

Setting Plug

E4PA-P01

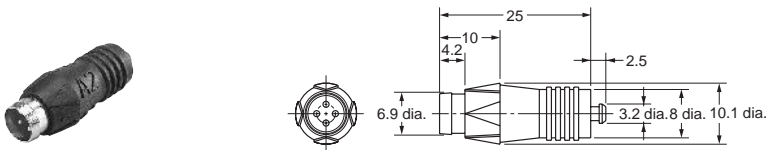

Certain Terms and Conditions of Sale

1. **Offer; Acceptance.** These terms and conditions (these "Terms") are deemed part of all catalogs, manuals or other documents, whether electronic or in writing, relating to the sale of goods or services (collectively, the "Goods") by Omron Electronics LLC and its subsidiary companies ("Seller"). Seller hereby objects to any terms or conditions proposed in Buyer's purchase order or other documents which are inconsistent with, or in addition to, these Terms. Please contact your Omron representative to confirm any additional terms for sales from your Omron company.
2. **Prices.** All prices stated are current, subject to change without notice by Seller. Buyer agrees to pay the price in effect at time of shipment.
3. **Discounts.** Cash discounts, if any, will apply only on the net amount of invoices sent to Buyer after deducting transportation charges, taxes and duties, and will be allowed only if (i) the invoice is paid according to Seller's payment terms and (ii) Buyer has no past due amounts owing to Seller.
4. **Orders.** Seller will accept no order less than \$200 net billing.
5. **Governmental Approvals.** Buyer shall be responsible for, and shall bear all costs involved in, obtaining any government approvals required for the importation or sale of the Goods.
6. **Taxes.** All taxes, duties and other governmental charges (other than general real property and income taxes), including any interest or penalties thereon, imposed directly or indirectly on Seller or required to be collected directly or indirectly by Seller for the manufacture, production, sale, delivery, importation, consumption or use of the Goods sold hereunder (including customs duties and sales, excise, use, turnover and license taxes) shall be charged to and remitted by Buyer to Seller.
7. **Financial.** If the financial position of Buyer at any time becomes unsatisfactory to Seller, Seller reserves the right to stop shipments or require satisfactory security or payment in advance. If Buyer fails to make payment or otherwise comply with these Terms or any related agreement, Seller may (without liability and in addition to other remedies) cancel any unshipped portion of Goods sold hereunder and stop any Goods in transit until Buyer pays all amounts, including amounts payable hereunder, whether or not then due, which are owing to it by Buyer. Buyer shall in any event remain liable for all unpaid accounts.
8. **Cancellation; Etc.** Orders are not subject to rescheduling or cancellation unless Buyer indemnifies Seller fully against all costs or expenses arising in connection therewith.
9. **Force Majeure.** Seller shall not be liable for any delay or failure in delivery resulting from causes beyond its control, including earthquakes, fires, floods, strikes or other labor disputes, shortage of labor or materials, accidents to machinery, acts of sabotage, riots, delay in or lack of transportation or the requirements of any government authority.
10. **Shipping; Delivery.** Unless otherwise expressly agreed in writing by Seller:
 - a. Shipments shall be by a carrier selected by Seller;
 - b. Such carrier shall act as the agent of Buyer and delivery to such carrier shall constitute delivery to Buyer;
 - c. All sales and shipments of Goods shall be FOB shipping point (unless otherwise stated in writing by Seller), at which point title to and all risk of loss of the Goods shall pass from Seller to Buyer, provided that Seller shall retain a security interest in the Goods until the full purchase price is paid by Buyer;
 - d. Delivery and shipping dates are estimates only.
 - e. Seller will package Goods as it deems proper for protection against normal handling and extra charges apply to special conditions.
11. **Claims.** Any claim by Buyer against Seller for shortage or damage to the Goods occurring before delivery to the carrier must be presented in writing to Seller within 30 days of receipt of shipment and include the original transportation bill signed by the carrier noting that the carrier received the Goods from Seller in the condition claimed.
12. **Warranties.** (a) **Exclusive Warranty.** Seller's exclusive warranty is that the Goods will be free from defects in materials and workmanship for a period of twelve months from the date of sale by Seller (or such other period expressed in writing by Seller). Seller disclaims all other warranties, express or implied. (b) **Limitations.** SELLER MAKES NO WARRANTY OR REPRESENTATION, EXPRESS OR IMPLIED, ABOUT NON-INFRINGEMENT, MERCHANTABILITY OR FITNESS FOR A PARTICULAR PURPOSE OF THE GOODS. BUYER ACKNOWLEDGES THAT IT ALONE HAS DETERMINED THAT THE GOODS WILL SUITABLY MEET THE REQUIREMENTS OF THEIR INTENDED USE. Seller further disclaims all warranties and responsibility of any type for claims or expenses based on infringement by the Goods or otherwise of any intellectual property right. (c) **Buyer Remedy.** Seller's sole obligation hereunder shall be to replace (in the form originally shipped with Buyer responsible for labor charges for removal or replacement thereof) the non-complying Good or, at Seller's election, to repay or credit Buyer an amount equal to the purchase price of the Good; provided that in no event shall Seller be responsible for warranty, repair, indemnity or any other claims or expenses regarding the Goods unless Seller's analysis confirms that the Goods were properly handled, stored, installed and maintained and not subject to contamination, abuse, misuse or inappropriate modification. Return of any goods by Buyer must be approved in writing by Seller before shipment. Seller shall not be liable for the suitability or unsuitability or the results from the use of Goods in combination with any electrical or electronic components, circuits, system assemblies or any other materials or substances or environments. Any advice, recommendations or information given orally or in writing, are not to be construed as an amendment or addition to the above warranty.
13. **Damage Limits; Etc.** SELLER SHALL NOT BE LIABLE FOR SPECIAL, INDIRECT OR CONSEQUENTIAL DAMAGES, LOSS OF PROFITS OR PRODUCTION OR COMMERCIAL LOSS IN ANY WAY CONNECTED WITH THE GOODS, WHETHER SUCH CLAIM IS BASED IN CONTRACT, WARRANTY, NEGLIGENCE OR STRICT LIABILITY. Further, in no event shall liability of Seller exceed the individual price of the Good on which liability is asserted.
14. **Indemnities.** Buyer shall indemnify and hold harmless Seller, its affiliates and its employees from and against all liabilities, losses, claims, costs and expenses (including attorney's fees and expenses) related to any claim, investigation, litigation or proceeding (whether or not Seller is a party) which arises or is alleged to arise from Buyer's acts or omissions under these Terms or in any way with respect to the Goods. Without limiting the foregoing, Buyer (at its own expense) shall indemnify and hold harmless Seller and defend or settle any action brought against Seller to the extent that it is based on a claim that any Good made to Buyer specifications infringed intellectual property rights of another party.
15. **Property; Confidentiality.** The intellectual property embodied in the Goods is the exclusive property of Seller and its affiliates and Buyer shall not attempt to duplicate it in any way without the written permission of Seller. Notwithstanding any charges to Buyer for engineering or tooling, all engineering and tooling shall remain the exclusive property of Seller. All information and materials supplied by Seller to Buyer relating to the Goods are confidential and proprietary, and Buyer shall limit distribution thereof to its trusted employees and strictly prevent disclosure to any third party.
16. **Miscellaneous.** (a) **Waiver.** No failure or delay by Seller in exercising any right and no course of dealing between Buyer and Seller shall operate as a waiver of rights by Seller. (b) **Assignment.** Buyer may not assign its rights hereunder without Seller's written consent. (c) **Amendment.** These Terms constitute the entire agreement between Buyer and Seller relating to the Goods, and no provision may be changed or waived unless in writing signed by the parties. (d) **Severability.** If any provision hereof is rendered ineffective or invalid, such provision shall not invalidate any other provision. (e) **Setoff.** Buyer shall have no right to set off any amounts against the amount owing in respect of this invoice. (f) As used herein, "including" means "including without limitation".

Certain Precautions on Specifications and Use

1. **Suitability of Use.** Seller shall not be responsible for conformity with any standards, codes or regulations which apply to the combination of the Good in the Buyer's application or use of the Good. At Buyer's request, Seller will provide applicable third party certification documents identifying ratings and limitations of use which apply to the Good. This information by itself is not sufficient for a complete determination of the suitability of the Good in combination with the end product, machine, system, or other application or use. The following are some examples of applications for which particular attention must be given. This is not intended to be an exhaustive list of all possible uses of this Good, nor is it intended to imply that the uses listed may be suitable for this Good:
 - (i) Outdoor use, uses involving potential chemical contamination or electrical interference, or conditions or uses not described in this document.
 - (ii) Energy control systems, combustion systems, railroad systems, aviation systems, medical equipment, amusement machines, vehicles, safety equipment, and installations subject to separate industry or government regulations.
 - (iii) Systems, machines and equipment that could present a risk to life or property. Please know and observe all prohibitions of use applicable to this Good.

NEVER USE THE PRODUCT FOR AN APPLICATION INVOLVING SERIOUS RISK TO LIFE OR PROPERTY WITHOUT ENSURING THAT THE SYSTEM AS A WHOLE HAS BEEN DESIGNED TO ADDRESS THE RISKS, AND THAT THE SELLER'S PRODUCT IS PROPERLY RATED AND INSTALLED FOR THE INTENDED USE WITHIN THE OVERALL EQUIPMENT OR SYSTEM.
2. **Programmable Products.** Seller shall not be responsible for the user's programming of a programmable Good, or any consequence thereof.
3. **Performance Data.** Performance data given in this catalog is provided as a guide for the user in determining suitability and does not constitute a warranty. It may represent the result of Seller's test conditions, and the user must correlate it to actual application requirements. Actual performance is subject to the Seller's Warranty and Limitations of Liability.
4. **Change in Specifications.** Product specifications and accessories may be changed at any time based on improvements and other reasons. It is our practice to change part numbers when published ratings or features are changed, or when significant construction changes are made. However, some specifications of the Good may be changed without any notice. When in doubt, special part numbers may be assigned to fix or establish key specifications for your application. Please consult with your Seller's representative at any time to confirm actual specifications of purchased Good.
5. **Errors and Omissions.** The information in this catalog has been carefully checked and is believed to be accurate; however, no responsibility is assumed for clerical, typographical or proofreading errors, or omissions.

Complete “Terms and Conditions of Sale” for product purchase and use are on Omron’s website at www.omron.com/oei – under the “About Us” tab, in the Legal Matters section.

ALL DIMENSIONS SHOWN ARE IN MILLIMETERS.

To convert millimeters into inches, multiply by 0.03937. To convert grams into ounces, multiply by 0.03527.

OMRON[®]**OMRON ELECTRONICS LLC**

One Commerce Drive
Schaumburg, IL 60173

847-843-7900

For US technical support or other inquiries:

800-556-6766**OMRON CANADA, INC.**

885 Milner Avenue
Toronto, Ontario M1B 5V8

416-286-6465**OMRON ON-LINE**

Global - <http://www.omron.com>
USA - <http://www.omron.com/oei>
Canada - <http://www.omron.ca>